

GV-CBL2800 AI 2MP H.265 Low Lux WDR Full Color Warm LED IR Bullet IP

Camera



- AI deep learning: Smart Perimeter Protection
- 1/3.2" progressive scan CMOS sensor
- Min. illumination at 0.02 lux
- Dual streams from H.265, H.264 and MJPEG
- Up to 30 fps at 1920 x 1080
- Smart Warm LED distance up to 20 m (65 ft)
- Intelligent IR
- IR distance up to 30 m (100 ft)
- Wide Dynamic Range (WDR)
- Built-in microphone
- Ingress protection (IP67)
- PoE (IEEE 802.3af)
- AI analytics (Line Crossing, Region Intrusion)
- Defog
- 3D noise reduction
- Motion detection
- Text overlay
- Privacy mask
- 19 languages supported
- ONVIF (Profile S, M) conformant

Introduction

GV-CBL2800 is a 2 MP outdoor bullet IP camera, equipped with a smart warm LED for full color surveillance during nighttime. The camera supports H.265 video codec to achieve a better compression ratio while maintaining high-quality pictures at reduced network bandwidth. GV-CBL2800 adheres to the IP67 standard and can be powered through PoE.

Empowered by deep learning algorithms, AI technology distinguishes humans and vehicles from other moving objects. Integrated with GeoVision Video Management Software (GV-VMS), it supports AI perimeter protection, real-time alert, playback, and more.

Deep Learning Function

AI Perimeter Protection (Line Crossing, Region Intrusion)



Specifications

Camera					
Image Sensor		1/3.2" progressive scan CMOS			
Picture Elements		1920 (H) x 1080 (V)			
Minimum Illumination	Color	0.02 Lux (F2.0, AGC ON)			
	IR On	0 Lux			
Shutter Speed		Auto / Manual (1/3 ~ 1/100000 sec)			
White Balance		Auto / Manual			
Gain Control		Auto / Manual			
S/N Ratio		50 dB			
WDR		Yes			
Dynamic Range		90 dB			
Lens					
Megapixel		2 MP			
Day / Night		Yes			
Lens Type		Fixed			
Focal Length		2.8 mm			
Maximum Aperture		F/2.0			
Mount		M12			
FOV	Horizontal	90°			
	Vertical	50°			
	Diagonal	103°			
Operation	Focus	Fixed			
	Zoom	Fixed			
	Iris	Fixed			
IR LED	Quantity	1 IR LED			
	Max. IR Distance	30 m (100 ft)			
Smart Illumination	LED Quantity	1 Warm LED			
	Max. LED Distance	20 m (65 ft)			
DORI		Detect	Observe	Recognize	Identify
Lens	2.8 mm	46 m (151 ft)	19 m (61 ft)	9 m (30 ft)	5 m (16 ft)
Operation					
Video Compression		H.265, H.265+, H.264, H.264+, MJPEG			
Video Streaming		Dual streams			
Video Resolution	Main Stream	1920 x 1080 (Default), 1280 x 720			
	Sub Stream	704 x 576, 704 x 480 (Default), 640 x 480, 640 x 360, 480 x 240, 352 x 288, 352 x 240			
Frame Rate		30 fps at 1920 x 1080, 1280 x 720, 704 x 480, 640 x 480, 640 x 360, 480 x 240, 352 x 240 (60 Hz) 25 fps at 1920 x 1080, 1280 x 720, 704 x 576, 640 x 480, 640 x 360, 480 x 240, 352 x 288 (50 Hz) * The frame rate and performance may vary depending on the number of connections and data bitrates (different scenes).			
Maximum Throughput		24 Mbps			
Maximum Streams * When the total bitrate is within the maximum throughput		6			
Video Analytics		Motion Detection			
Smart Alarm		Motion Detection, IP Address Conflict, Cable Disconnection			
Image Settings		Brightness, Contrast, Hue, Saturation, Sharpness, 3D Noise Reduction, Defog, BLC, Antiflicker, Smart IR, Image Orientation (Flip, Mirror, 0°, 180°)			
Audio Compression		G.711			
Audio Support		One-way audio			
Deep Learning Function					
AI Analytics		Line Crossing, Region Intrusion (Human detection only) *The two functions can only be enabled one at a time.			

Network			
Interface	10/100 Ethernet		
Protocol	802.1X authentication (EAP-TLS, EAP-MD5), DDNS, DHCP, HTTP, IPv4, IPv6, NTP, ONVIF (Profile S, M), QoS, RTMP, RTSP, UDP		
Mechanical			
Camera Angle Adjustment	Pan	0 ~ 360°	
	Tilt	0 ~ 80°	
	Rotate	0 ~ 360°	
Connectors	Ethernet	RJ-45 connector	
	Audio	Built-in microphone	Yes
		External microphone required	No
		Built-in speaker	No
	External speaker required	No	
General			
Operating Temperature	-20°C ~ 55°C (-4°F ~ 131°F)		
Humidity	0% ~ 95% (no condensation)		
Power Source	PoE (IEEE 802.3af)		
Max. Power Consumption	5.5 W		
Dimensions	162.1 x 74.8 x 73.8 mm (6.38 x 2.94 x 2.90 in)		
Weight	0.25 kg (0.55 lb)		
Ingress Protection	IP67		
Certification	CE, RoHS compliant		
Web Interface			
Installation Management	Web-based configuration		
Maintenance	Firmware upgrade through Web Browser or Utility		
Access from Web Browser	Live View, Video Recording, Change Video Quality, Bandwidth Control, Image Snapshot, Digital Zoom, Text Overlay, Image Masking, Intelligent Mark		
Language	Chinese Traditional, Czech, Dutch, English, French, German, Hebrew, Hungarian, Italian, Japanese, Korean, Norwegian, Polish, Portuguese, Romanian, Russian, Spanish, Spanish (Latin America), Turkish		
Software Applications			
Software Supported	GV-VMS (V17.4.8 / V18.3.5 or later, patch files required), GV-Control Center (V4.2.1 or later, patch files required), GV-Edge Recording Manager for Windows (V2.3.1 or later, patch files required), GV-Recording Server (V2.1.1 or later, patch files required), GV-IP Device Utility (V9.0.5 or later) *You need to purchase an HD DVR License (dongle or software license) for the GV-C Series IP cameras to connect to the GV-VMS and GV-Recording Server software.		
Smart Device Access	GV-Eye for iOS and Android (V3.4.1 or later)		
Live Viewing	Web Browser (Edge, Chrome, Firefox, Safari), Mobile App		







Note:

1. Do not use clothes or any ordinary material to clean the camera cover since they may result in scratches.
2. All specifications are subject to change without notice.

Packing List

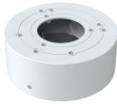
- | | |
|-----------------------------|--------------------------|
| 1. GV-CBL2800 Bullet Camera | 4. Drill Template Paster |
| 2. Waterproof Rubber Set | 5. Download Guide |
| 3. Screw Kit | |

Accessories

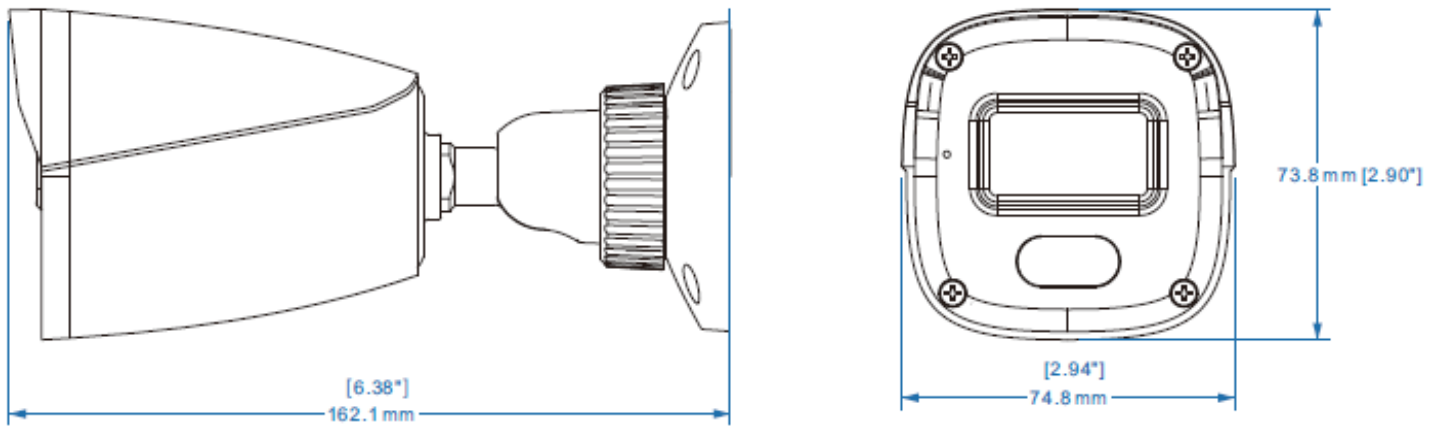

Model No.	Name		Details
GV-Mount117 (must be used with GV-Mount506-1)	Pendant Mount		Dimensions: \varnothing 121 x 191.4 mm (\varnothing 4.76 x 7.54 in) Weight: 0.4 kg (0.88 lb)
GV-Mount470 (must be used with GV-Mount506-1)	Pole Mount Bracket		Dimensions: 163.3 x 54.5 x 215 mm (6.43 x 2.15 x 8.46 in) Weight: 1.10 kg (2.43 lb)
GV-Mount506-1	Junction Box		Dimensions: 117.9 x 143.3 x 47 mm (4.64 x 5.64 x 1.85 in) Weight: 0.38 kg (0.84 lb)
GV-Mount507	Junction Box		Dimensions: \varnothing 96 x 38.8 mm (\varnothing 3.78 x 1.53 in) Weight: 0.16 kg (0.30 lb)
GV-Mount507-1	Junction Box		Dimensions: \varnothing 111.7 x 55 mm (\varnothing 4.40 x 2.17 in) Weight: 0.33 kg (0.73 lb)
GV-Mount707 (must be used with GV-Mount117)	Extension Tube		Dimensions: \varnothing 37 x 515 mm (\varnothing 1.46 x 20.28 in) Weight: 0.8 kg (1.76 lb)
GV-PA191	PoE Adapter		GV-PA191 is a Power over Ethernet (PoE) adapter designed to provide power to the IP device through a single Ethernet cable.
GV-PA301	Gigabit PoE Adapter		GV-PA301 is a Gigabit Power over Ethernet (PoE) adapter.
GV-POE Switch	GV-POE Switch is designed to provide power along with network connection for IP devices. The GV-POE Switch is available in various models with different numbers and types of ports.		

Dimensions

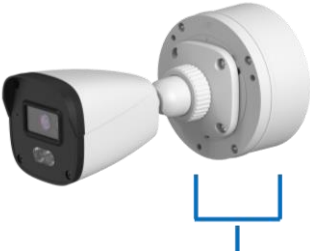
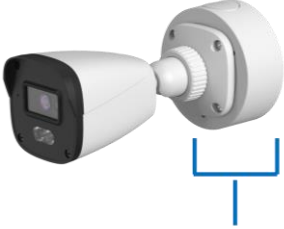

Mounting Type

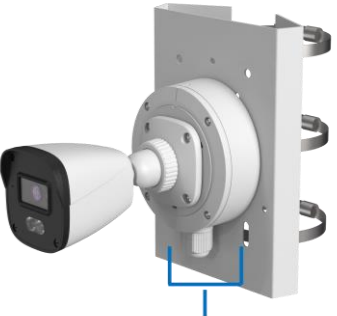
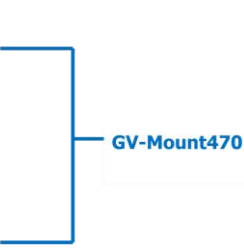
Junction Box Mount GV-Mount506-1	Junction Box Mount GV-Mount507	Junction Box Mount GV-Mount507-1
 GV-Mount506-1	 GV-Mount507	 GV-Mount507-1

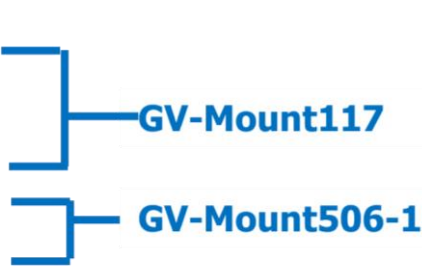
Junction Box Mount GV-Mount506-1	Pole Bracket Mount GV-Mount470	Junction Box Mount GV-Mount506-1	Pendant Mount GV-Mount117
 GV-Mount506-1	 GV-Mount470	 GV-Mount506-1	 GV-Mount117 GV-Mount506-1